



# CDC-675/575

*NATURAL SOUND COMPACT DISC PLAYER*  
*CHANGEUR AUTOMATIQUE DE COMPACT DISQUES*



## OWNER'S MANUAL



### CONTENTS

CAUTION .....	4
CONNECTIONS .....	5
IDENTIFICATION OF COMPONENTS .....	6
BASIC OPERATION .....	8
RANDOM-SEQUENCE PLAY .....	13
PROGRAM PLAY .....	14
REPEAT PLAY .....	16
INDEX SEARCH .....	16
CD SYNCHRONIZED RECORDING .....	17
TRACK PROGRAMMING FOR RECORDING TO TAPE <b>for CDC-675 only</b> .....	18
AUTOMATIC SEARCHING FOR THE PEAK LEVEL ON A DISC <b>for CDC-675 only</b> .....	21
NOTES ABOUT THE REMOTE CONTROL TRANSMITTER .....	22
TIMER PLAY <b>for CDC-675 only</b> .....	22
NOTES ABOUT HANDLING COMPACT DISCS .....	23
TROUBLESHOOTING .....	24
SPECIFICATIONS .....	24

## MODE D'EMPLOI

### TABLE DES MATIERES

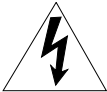
ATTENTION .....	26
CONNEXIONS .....	27
IDENTIFICATION DES COMPOSANTS .....	28
FONCTIONNEMENT DE BASE .....	30
LECTURE EN SÉQUENCE ALÉATOIRE .....	35
LECTURE PROGRAMMÉE .....	36
LECTURE REPETÉE .....	38
RECHERCHE D'INDEX .....	38
ENREGISTREMENT SYNCHRONISÉ D'UN COMPACT DISQUE .....	39
PROGRAMMATION DES PLAGES POUR ENREGISTREMENT SUR CASSETTE <b>CDC-675 seulement</b> .....	40
RECHERCHE AUTOMATIQUE DU NIVEAU DE CRÊTE D'UN DISQUE <b>CDC-675 seulement</b> .....	43
REMARQUES CONCERNANT LA TELECOMMANDE .....	44
LECTURE COMMANDÉE PAR PROGRAMMATEUR <b>CDC-675 seulement</b> .....	44
REMARQUES CONCERNANT LA MANIPULATION DES DISQUES .....	45
DEPISTAGE DE PANNES .....	46
CARACTERISTIQUES TECHNIQUES .....	46

	<b>CAUTION</b> RISK OF ELECTRIC SHOCK DO NOT OPEN	
<p>CAUTION: TO REDUCE THE RISK OF ELECTRIC SHOCK, DO NOT REMOVE COVER (OR BACK). NO USER-SERVICEABLE PARTS INSIDE. REFER SERVICING TO QUALIFIED SERVICE PERSONNEL.</p>		

**IMPORTANT!**  
Please record the serial number of this unit in the space below.

Model:  
Serial No.:

The serial number is located on the rear of the unit.  
Retain this Owner's Manual in a safe place for future reference

• Explanation of Graphical Symbols

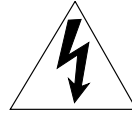

The lightning flash with arrowhead symbol, within an equilateral triangle, is intended to alert you to the presence of uninsulated "dangerous voltage" within the product's enclosure that may be of sufficient magnitude to constitute a risk of electric shock to persons.



The exclamation point within an equilateral triangle is intended to alert you to the presence of important operating and maintenance (servicing) instructions in the literature accompanying the appliance.

**WARNING**  
TO REDUCE THE RISK OF FIRE OR ELECTRIC SHOCK, DO NOT EXPOSE THIS UNIT TO RAIN OR MOISTURE.

# SAFETY INSTRUCTIONS

- 1 Read Instructions – All the safety and operating instructions should be read before the unit is operated.
- 2 Retain Instructions – The safety and operating instructions should be retained for future reference.
- 3 Heed Warnings – All warnings on the unit and in the operating instructions should be adhered to.
- 4 Follow Instructions – All operating and other instructions should be followed.
- 5 Water and Moisture – The unit should not be used near water – for example, near a bathtub, washbowl, kitchen sink, laundry tub, in a wet basement, or near a swimming pool, etc.
- 6 Carts and Stands – The unit should be used only with a cart or stand that is recommended by the manufacturer.
- 6A A unit and cart combination should be moved with care. Quick stops, excessive force, and uneven surfaces may cause the unit and cart combination to overturn.
- 7 Wall or Ceiling Mounting – The unit should be mounted to a wall or ceiling only as recommended by the manufacturer.
- 8 Ventilation – The unit should be situated so that its location or position does not interfere with its proper ventilation. For example, the unit should not be situated on a bed, sofa, rug, or similar surface, that may block the ventilation openings; or placed in a built-in installation, such as a bookcase or cabinet that may impede the flow of air through the ventilation openings.
- 9 Heat – The unit should be situated away from heat sources such as radiators, stoves, or other appliances that produce heat.
- 10 Power Sources – The unit should be connected to a power supply only of the type described in the operating instructions or as marked on the unit.
- 11 Power-Cord Protection – Power-supply cords should be routed so that they are not likely to be walked on or pinched by items placed upon or against them, paying particular attention to cords at plugs, convenience receptacles, and the point where they exit from the unit.
- 12 Cleaning – The unit should be cleaned only as recommended by the manufacturer.
- 13 Nonuse Periods – The power cord of the unit should be unplugged from the outlet when left unused for a long period of time.
- 14 Object and Liquid Entry – Care should be taken so that objects do not fall into and liquids are not spilled into the inside of the unit.
- 15 Damage Requiring Service – The unit should be serviced by qualified service personnel when:
  - A. The power-supply cord or the plug has been damaged; or
  - B. Objects have fallen, or liquid has been spilled into the unit; or
  - C. The unit has been exposed to rain; or
  - D. The unit does not appear to operate normally or exhibits a marked change in performance; or
  - E. The unit has been dropped, or the cabinet damaged.
- 16 Servicing – The user should not attempt to service the unit beyond those means described in the operating instructions. All other servicing should be referred to qualified service personnel.
- 17 Power Lines – An outdoor antenna should be located away from power lines.
- 18 Grounding or Polarization – Precautions should be taken so that the grounding or polarization is not defeated.



## FCC INFORMATION (for US customers only)

### 1. IMPORTANT NOTICE : DO NOT MODIFY THIS UNIT!

This product, when installed as indicated in the instructions contained in this manual, meets FCC requirements. Modifications not expressly approved by Yamaha may void your authority, granted by the FCC, to use the product.

### 2. IMPORTANT : When connecting this product to accessories and/or another product use only high quality shielded cables. Cable/s supplied with this product MUST be used. Follow all installation instructions. Failure to follow instructions could void your FCC authorization to use this product in the USA.

### 3. NOTE : This product has been tested and found to comply with the requirements listed in FCC Regulations, Part 15 for Class "B" digital devices. Compliance with these requirements provides a reasonable level of assurance that your use of this product in a residential environment will not result in harmful interference with other electronic devices.

This equipment generates/uses radio frequencies and, if not installed and used according to the instructions found in the users manual, may cause interference harmful to the operation of other electronic devices.

Compliance with FCC regulations does not guarantee that interference will not occur in all installations. If this product is found to be the source of interference, which can be determined by turning the unit "OFF" and "ON", please try to eliminate the problem by using one of the following measures:

Relocate either this product or the device that is being affected by the interference.

Utilize power outlets that are on different branch (circuit breaker or fuse) circuits or install AC line filter/s.

In the case of radio or TV interference, relocate/reorient the antenna. If the antenna lead-in is 300 ohm ribbon lead, change the lead-in to coaxial type cable.

If these corrective measures do not produce satisfactory results, please contact the local retailer authorized to distribute this type of product. If you can not locate the appropriate retailer, please contact Yamaha Electronics Corp., U.S.A. 6660 Orangethorpe Ave, Buena Park, CA 90620.

The above statements apply ONLY to those products distributed by Yamaha Corporation of America or its subsidiaries.

## WARNING

### CAUTION

Use of controls or adjustments or performance of procedures other than those specified herein may result in hazardous radiation exposure.

### DANGER

Invisible laser radiation when open and interlock failed or defeated.  
Avoid direct exposure to beam.

As the laser beam used in this compact disc player is harmful to the eyes, do not attempt to disassemble the cabinet. Refer servicing to qualified personnel only.

To avoid electrical shock, do not open the unit. Refer servicing to qualified personnel only.

**DANGER:** The use of optical instrument with this product will increase eye hazard.

### For Canadian Customers

To prevent electric shock, match wide blade of plug to wide slot and fully insert.

This Class B digital apparatus complies with Canadian ICES-003.

### Laser Diode Properties

- Material: GaAlAs
- Wavelength: 780nm
- Emission Duration: continuous
- Laser Output: max. 44.6 $\mu$ W\*

\* This output is the value measured at a distance of about 200mm from the objective lens surface on the Optical Pick-up Block.

## We Want You Listening For A Lifetime

YAMAHA and the Electronic Industries Association's Consumer Electronics Group want you to get the most out of your equipment by playing it at a safe level. One that lets the sound come through loud and clear without annoying blaring or distortion – and, most importantly, without affecting your sensitive hearing. Since hearing damage from loud sounds is

often undetectable until it is too late, YAMAHA and the Electronic Industries Association's Consumer Electronics Group recommend you to avoid prolonged exposure from excessive volume levels.



---

**CAUTION: READ THIS BEFORE OPERATING YOUR UNIT**

---

- 1 To ensure the finest performance, please read this manual carefully. Keep it in a safe place for future reference.
- 2 Install your unit in a cool, dry, clean place, and in a horizontal and stable position – away from windows, heat sources, vibration, dust, moisture, or cold. To avoid humming sounds, locate the unit away from other electrical appliances, motors, and transformers. To prevent fire or electrical shock, do not expose to rain and water.
- 3 Do not operate the unit upside-down. It may overheat, possibly causing damage.
- 4 Never open the cabinet. If a foreign object drops into the set, contact your dealer.
- 5 Do not use force on switches, knobs or cords.
- 6 Do not attempt to clean the unit with chemical solvents; this might damage the finish. Use a clean, dry cloth.
- 7 Be sure to read the “TROUBLESHOOTING” section on common operating errors before concluding that your unit is faulty.
- 8 Do not place another component on top of this unit, because to do so will discolor or damage the surface of the unit.
- 9 To prevent damage by lightning, disconnect the power cord from the household AC outlet during an electrical storm.
- 10 When disconnecting the power cord from the household AC outlet, grasp the plug; do not pull the cord.

**CAUTION FOR CARRYING THIS UNIT**

Be sure not to carry or tip this unit with discs remaining in it.

**CAUTION FOR MOVING THIS UNIT**

When moving this unit, first remove all discs from the disc tray and close the tray by pressing the **OPEN/CLOSE** button. After you confirm that the display lights up as shown below, switch off the power by pressing the **POWER** switch, and then disconnect the power plug from the AC outlet.



Never switch off the power until the display lights up as above, otherwise this unit will break down during moving because the internal mechanism is not locked.

---

**FEATURES**

---

- **5-Disc Carousel Auto-changer**
  - **Full Opening Disc Tray for Changing 5 Discs at a Time**
  - **PLAYXCHANGE; Disc Changing Capability while Playing Another**
  - **CD TEXT Compatibility**
  - **Random Access Programmable Play**
  - **Random-Sequence Play**
  - **Single Track/Entire Disc/All Disc Repeat Play**
  - **Adjustable Display Brightness**
  - **Remote Control Capability**
  - **Disc Scanning Capability Useful for Disc Searching or Disc Checking**
  - **CD Synchronized Recording with a Compatible YAMAHA Tape Deck**
  - **Optical Digital Output**
- CDC-675 only**
- **Automatic Programming for Recording to Tape**
  - **Timer Play Option**
  - **Automatic Peak Level Searching Capability**
  - **Adjusting the Output Level**
  - **PHONES jack**

# CONNECTIONS

**Never plug in this unit and other components until all connections are completed.**

- Before making any connections, switch OFF the power to the unit and the amplifier or other components.
- Connections should be made to the correct input terminals of the amplifier or other components.
- If the placement of this unit causes noise in other equipment, such as a tuner, separate them from each other.

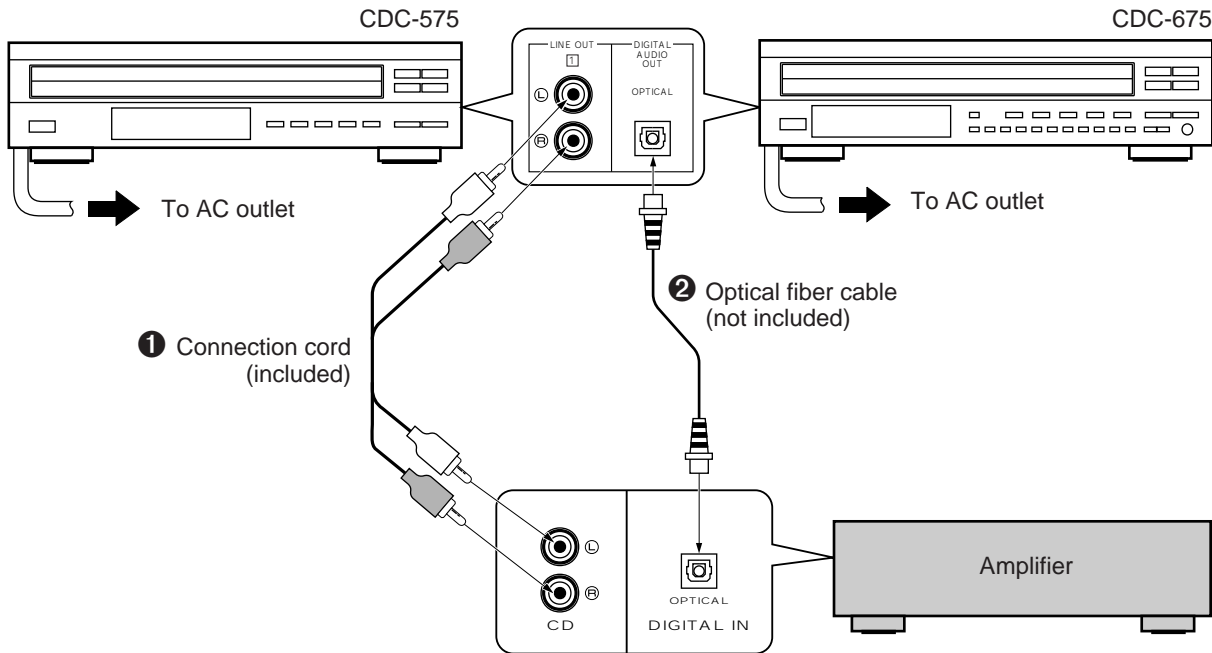

Choose one of the ways listed below to connect this unit to your amplifier.

## When the LINE OUT (analog) terminals of this unit are used ( ❶ )

- Be sure that the left (“L”) and right (“R”) LINE OUT terminals are connected to the corresponding (left and right) terminals of the amplifier or other components.
- Connect the “LINE OUT” terminals to the “CD” (or “AUX”) terminals of the amplifier. If the amplifier does not have such terminals, use the “TAPE PB” terminals. For additional details concerning these connections, refer to the operation instructions for the amplifier being used.
- The LINE OUT terminals of this unit are numbered ❶. When connecting this unit with a YAMAHA amplifier or receiver whose terminals on the rear panel are numbered as ❶, ❷, ❸, etc., connect the LINE OUT terminals of this unit to the input terminals numbered ❶ on the rear of the amplifier or receiver.

## When the DIGITAL AUDIO OUT (OPTICAL) terminal of this unit is used ( ❷ )

- Before using this terminal, remove the terminal’s cover by pulling it.
- Make the connection from this terminal to the optical input terminal of an amplifier by using a commercially available optical fiber cable.
  - \* Be sure to use a high quality optical fiber cable. Other cables might not function correctly.
- This terminal can also be connected to the optical input terminal of a digital audio tape deck (DAT), etc. to record CD onto tape directly.
- Be sure to attach the terminal cover when this terminal is not being used in order to protect the terminal from dust.
- **CDC-675 only**
  - Set the level of signals output into an amplifier to max. by using the **OUTPUT LEVEL** buttons.

## For Custom Installer For U.S.A., Canada and Australia models of CDC-675 only

### REMOTE CONTROL (IN, OUT) terminals

These terminals are used for custom installation system. When this unit is connected to the components for custom installation system, you can operate this unit with the system remote control. Connect the **REMOTE CONTROL IN** terminal of this unit to the output terminal of the central controller for custom installation system.

By connecting the **REMOTE CONTROL OUT** terminal of this unit to the REMOTE CONTROL IN terminal of the other component, you can also operate it with the system remote control. In this way, up to 6 components can be connected in series.

# IDENTIFICATION OF COMPONENTS

\* ( ) indicates the page number on which the control and its function are best described.

## FRONT PANEL

\* The control functions on the main unit and on the remote control transmitter are virtually identical, with the exceptions below.

- \* The **▷/⏸** (PLAY/PAUSE) button on the main unit has both the functions of the **PLAY** button and the **PAUSE** button on the remote control transmitter.
- \* The **SKIP/SEARCH** buttons on the main unit have both the functions of the **SKIP** button and the **SEARCH** button on the remote control transmitter.

### CDC-675

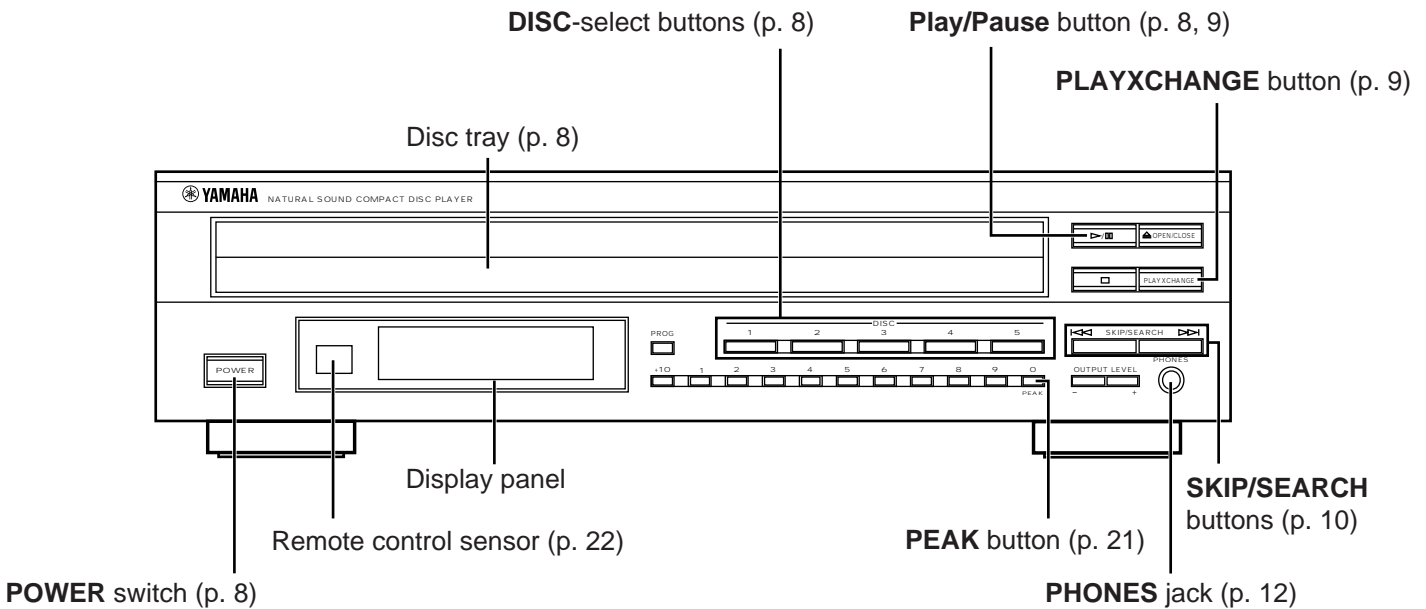

### CDC-575

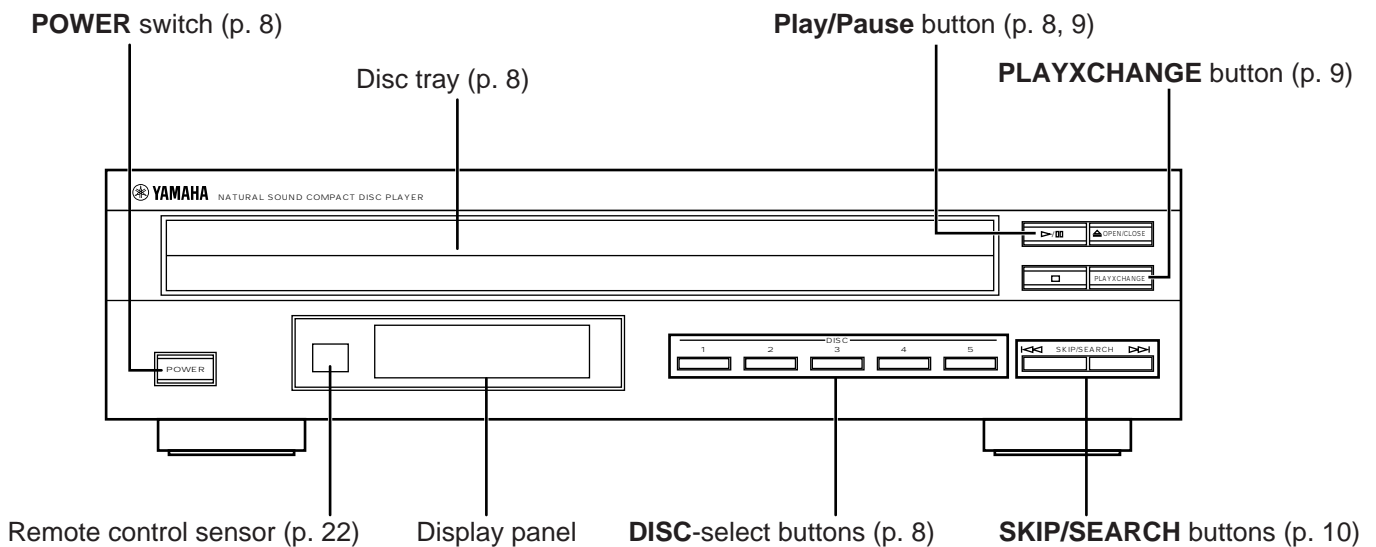

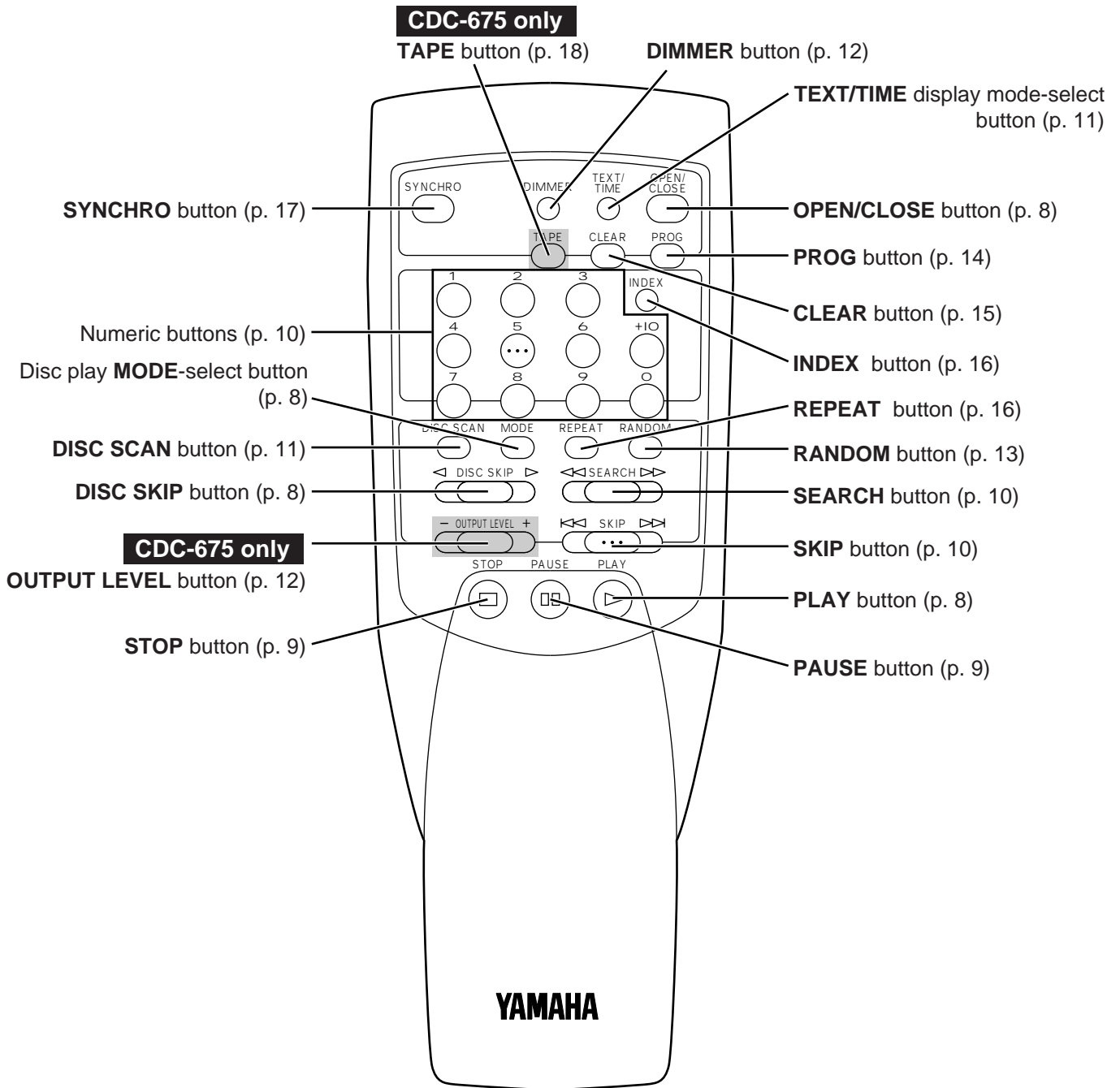

Parts in the shaded areas are provided for CDC-675 only.

This manual describes how to operate this unit by using the remote control transmitter. To operate this unit on the front panel, use the corresponding buttons on the front panel.

# BASIC OPERATION

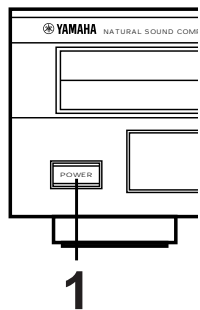

**CDC-675**

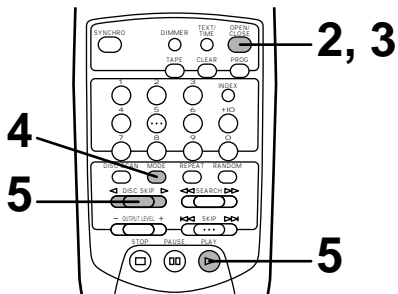

**CDC-575**

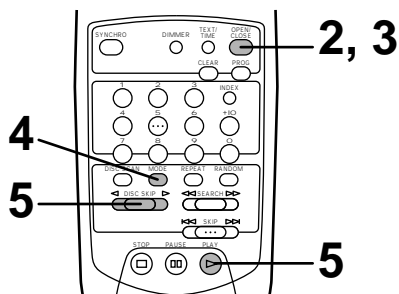

**1** Turn the power on.

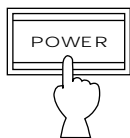

**2** Open the disc tray and load discs. Use the disc guides to align the discs correctly in the tray.

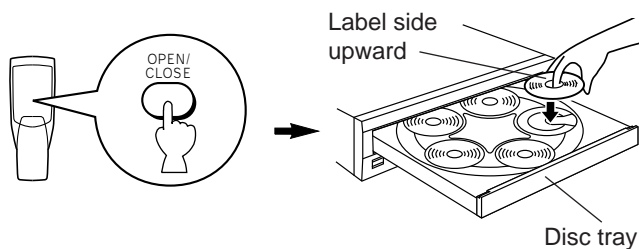

**3** Close the disc tray.

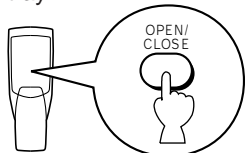

**4** Select a desired disc play mode (1DISC or 5DISCS) confirming it on the display.

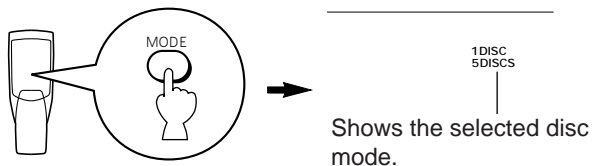

**“1DISC” mode:** The unit will play a designated disc only.  
**“5DISCS” mode:** The unit will play all discs on the tray in sequence.

**5** Start play from the first track of the disc 1.

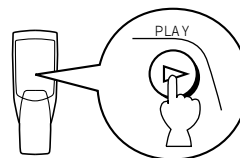

\* If necessary, select a desired disc by using the **DISC SKIP** button or a **DISC-select** button.

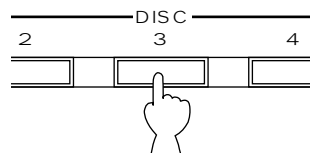
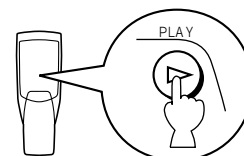
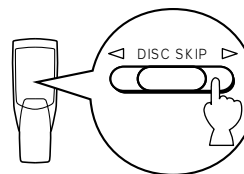

(On the front panel)

**To turn off the power**  
 Press the **POWER** switch again.



## Notes

- After closing the disc tray by pressing the **OPEN/CLOSE** button or selecting any disc by using the **DISC SKIP** button when this unit is stopped, the display shows the total number of tracks and the total recorded time of the selected disc for a few seconds.

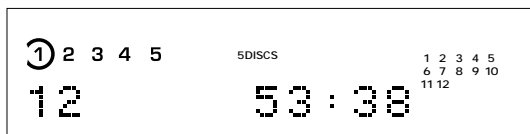

- You can also close the disc tray by pressing the **PLAY** (▶/⏮) button, a **DISC-select** button on the front panel, a numeric button or the **RANDOM** button, or by pressing the front edge of the disc tray gently. If the tray is closed in these ways, play will begin automatically, however, the display will not show the total number of tracks and the total recorded time of the first selected disc.

## PLAYXCHANGE

During play, you can open the disc tray by pressing the **PLAYXCHANGE** button on the front panel without interrupting disc play. However, in this case, pressing the **DISC SKIP** button has no effect. You can load or replace discs on the trays when the disc tray is opening, however, never load a disc on the tray hidden inside the unit. If doing so, the disc and the unit may be damaged, because the tray already has a disc, which is being played.

## CD TEXT

This unit is compatible with the CD TEXT function. The CD TEXT disc has information, such as the disc title, artist names, and track names. If the current disc is a CD TEXT disc, the unit reads the disc title, artist name, and track names from the disc. You can display the CD TEXT data (see "Selecting time displays and the text data" on page 11).

## Display information at disc play

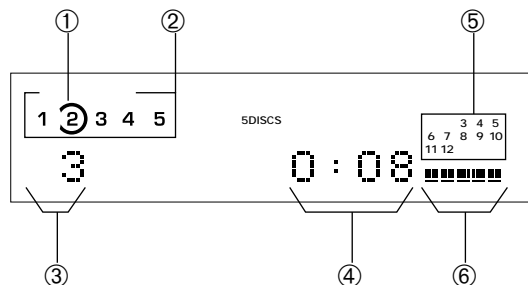

- Encloses the tray number of the selected disc.
- The numbers corresponding to trays that contain discs light up after discs are selected.
- Shows the selected track number.
- Shows the time displays. (Refer to "Selecting time displays and the text data" on page 11.)
- Displays the numbers that correspond to the numbers of the tracks (as high as number 20) on the selected disc. After each track is played, its corresponding number disappears so the number of remaining tracks (and their numbers) can be seen at a glance.
- CDC-675 only**  
Shows the level of signals output into an amplifier or the headphones level adjusted by using the **OUTPUT LEVEL** buttons.

## To play a 8-cm (3-inch) CD

Place it in the inner recessed area of the disc tray. Do not put a normal (12-cm/5-inch) CD on top of a 8-cm CD.

### To stop play temporarily

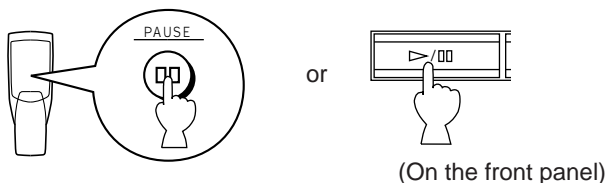

### To stop play completely

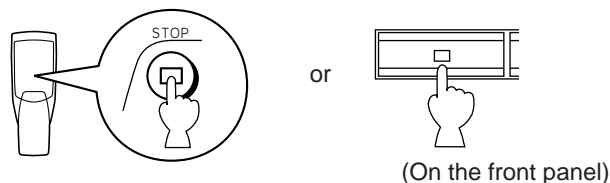

To resume play, press the **PAUSE** button again (or press the **PLAY** button).

\* The ▶/⏮ (PLAY/PAUSE) button on the front panel can also be used to stop play temporarily or to resume play.

## To play a desired track on the disc

### DIRECT PLAY

Select a desired track by using the numeric buttons.

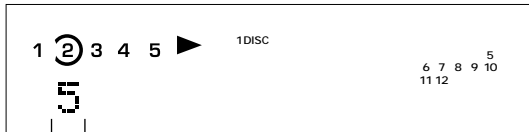
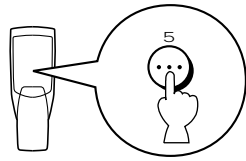

The selected track number is displayed.

Example: To select track 25  
Press ① twice, then immediately press ② once.

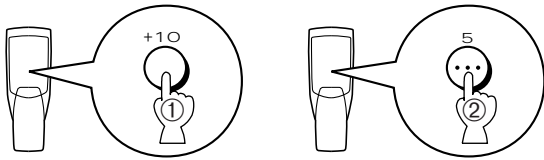

\* If a track number higher than the highest track number on the disc is selected, the last track on the disc will be played.

### SKIP PLAY

To play from the beginning of the track following the one now playing

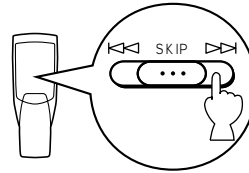

To play from the beginning of the track now playing

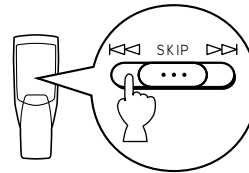

To play from the beginning of the track before the one now playing

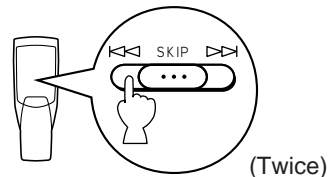

- These operations can also be performed when the unit is paused or stopped.
- When using the **SKIP** button on the remote control transmitter:
  - \* If the button is pressed and held, the track number is continuously changed to higher numbers (or lower numbers).
- When using the **SKIP/SEARCH** buttons on the front panel:
  - \* Be careful not to press and hold a button, otherwise the selected track is played forward (or backward) rapidly.

## To play forward or backward rapidly (MANUAL SEARCH)

### To go forward rapidly

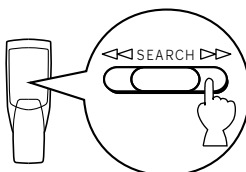

(Press and hold.)

### To go backward rapidly

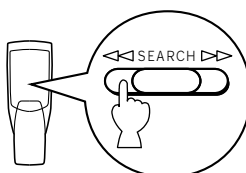

(Press and hold.)

- The sound can be heard (although slightly garbled) during manual search in either direction. This is convenient for locating a precise position within a track, or for reviewing the contents quickly.
- Manual search can also be performed while disc play is paused. In this case, no sound will be heard.
- When using the **SKIP/SEARCH** buttons on the front panel:
  - \* Be careful not to release the button just after it is pressed, otherwise the play is skipped to the beginning of the next track or returned to the beginning of the current track.

## Scanning discs to search for a desired disc (or to check discs on the disc tray)

When the **DISC SCAN** button is pressed in stop mode, this unit will play a section of each disc in turn for 8 seconds.

If, during this play, you find a disc that you want to listen to, press the **DISC SCAN** button once again or press the **PLAY** button to cancel this function. The unit will enter into the normal play mode.

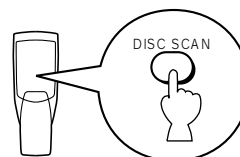

### Notes

- During this play, the disc tray numbers blink in the display. Every time the play of a disc is finished, the corresponding tray number is changed from flashing to lighting.
- If the disc being played has a long blank space between tracks, you will hear no sound during disc scan.

## Selecting time displays and the text data

You can select any of the four time displays by pressing the **TEXT/TIME** display mode-select button. When you play a CD with CD TEXT, the disc title, artist name, and track name are also displayed. Each time you press the **TEXT/TIME** display mode-select button, the display changes as follows.

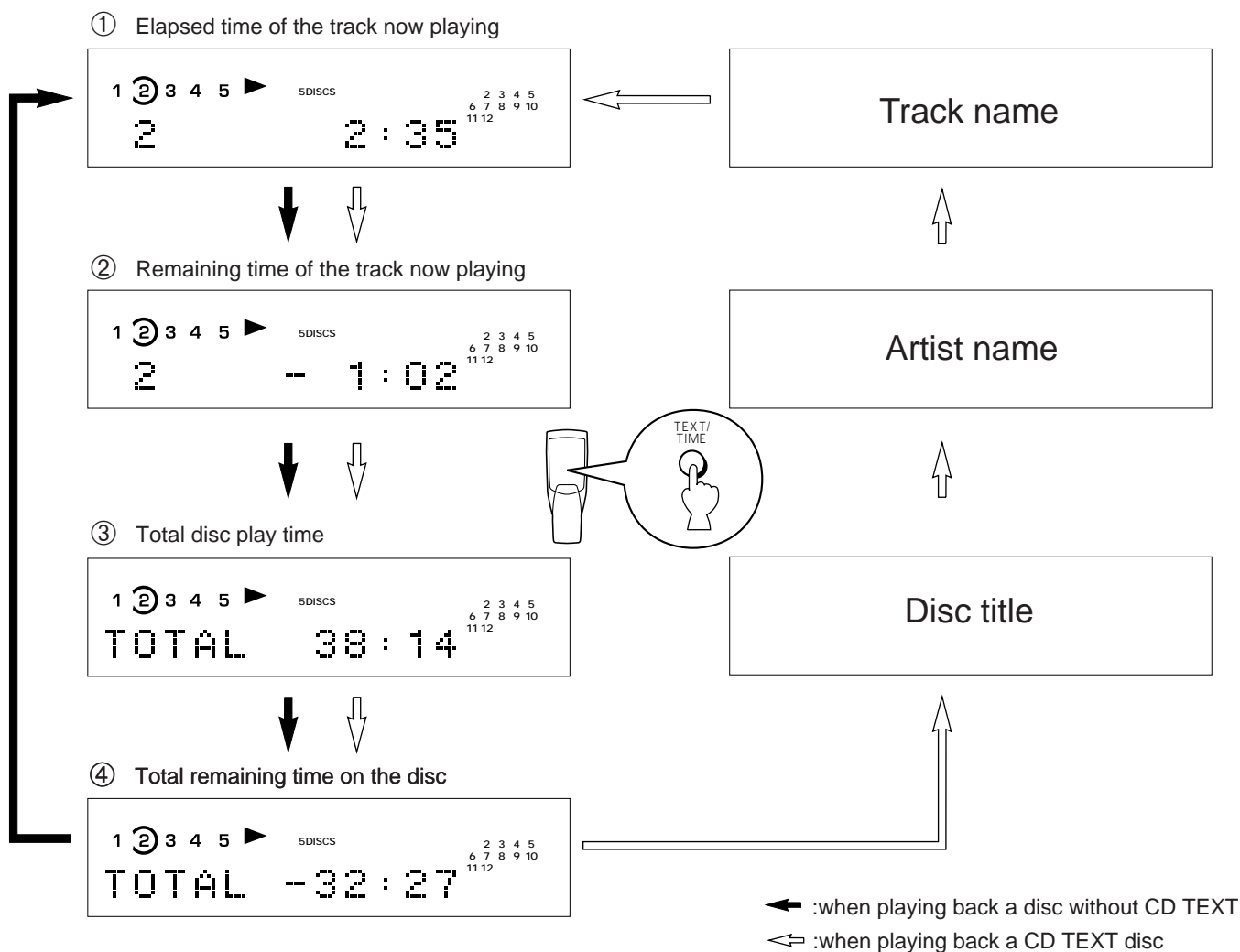

### Notes

- The remaining time ② will not be displayed if the track number is 21 or higher.
- The disc title, artist names, or track names may not be displayed with some CD TEXT discs. In this case, "(NO ENTRY)" appears in the display.

## Changing brightness of the display

If desired, you can change brightness of the display in three degrees by pressing the **DIMMER** button.

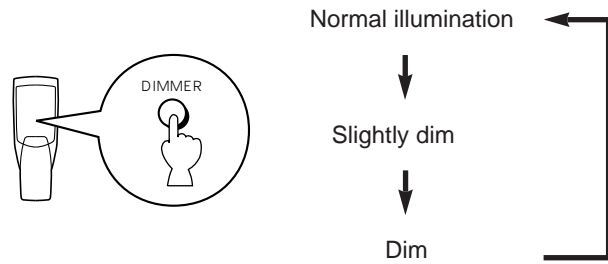

### CDC-675 only

#### Adjusting the level of signals output into an amplifier, etc.

You can adjust the level of sound signals output from the **LINE OUT** terminals on the rear panel into an amplifier, etc. as you prefer by using the **OUTPUT LEVEL** buttons.

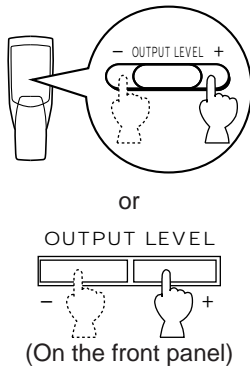

### CDC-675 only

#### When you listen with headphones

Connect the headphones to the **PHONES** jack and adjust the volume by using the **OUTPUT LEVEL** buttons.

\* Note that the use of the **OUTPUT LEVEL** buttons will also vary the level of the signal output to an amplifier, etc.

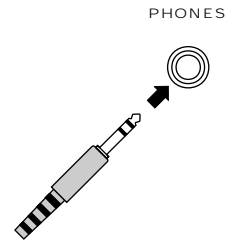

#### For optimum sound quality

- \* When the **DIGITAL AUDIO OUT (OPTICAL)** terminal is used for the connection, set the level of output signals to max.
- \* The level of output signals can be checked in the display.



# RANDOM-SEQUENCE PLAY

You can play the tracks in a random sequence (up to 99 tracks). The unit will automatically mix up tracks from all discs or a designated disc on the disc tray.

## CDC-675

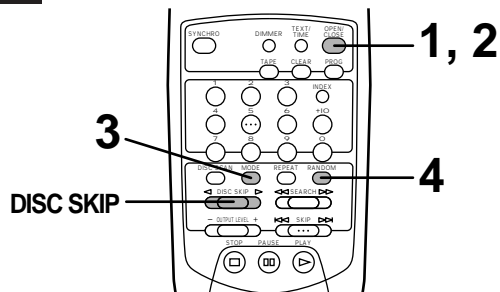

## CDC-575

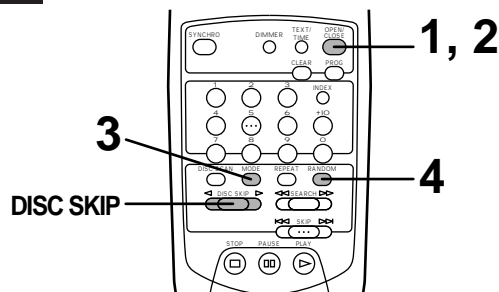

**1** Load one or more discs.

**2** Close the disc tray.

**3** Select a desired disc play mode (1DISC or 5DISCS).

\* If you select "1DISC" mode, next select a desired disc by using the **DISC SKIP** button on the remote control transmitter or a **DISC-select** button on the front panel.

**4**

"RNDM" lights up on the display.

### To cancel random-sequence play

Press the **STOP** button or **RANDOM** button once again, or open the disc tray by pressing the **OPEN/CLOSE** button. "RNDM" disappears from the display.

### Notes

- This feature will not function during programming, or during program play.
- If the **SKIP** >>> button is pressed during random-sequence play, the next randomly programmed track will be played. If the **SKIP** <<< button is pressed, play will return to the beginning of the track now being played.
-  This indication appears while the unit is mixing up tracks.
- Total remaining time on the disc will not be displayed during random-sequence play.

# PROGRAM PLAY

You can enjoy listening to your favorite tracks selected from one or more discs in any desired order by programming tracks.

## CDC-675

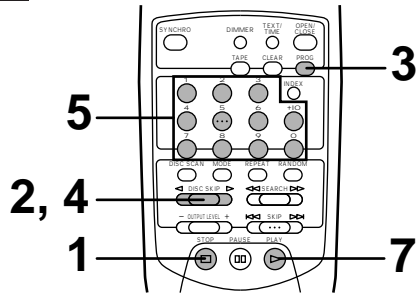

## CDC-575

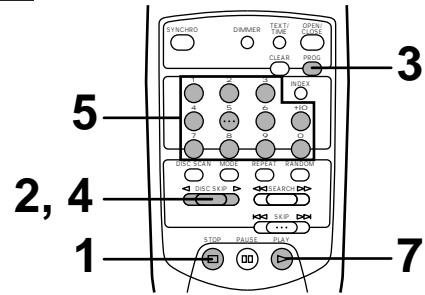

### 1 Stop the unit.

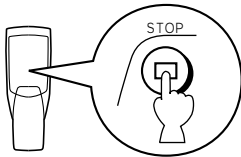

### 2 If you will select tracks from a disc (or discs) other than the disc on the Disc 1 tray, make this unit display the total recorded time of each disc to be used by pressing the DISC SKIP button in turn.

\* Without this operation, the total time of the programmed tracks will not be displayed during programming.

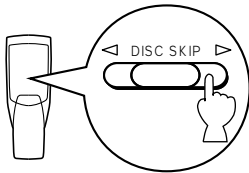

### 3 Press the PROG button to begin programming.

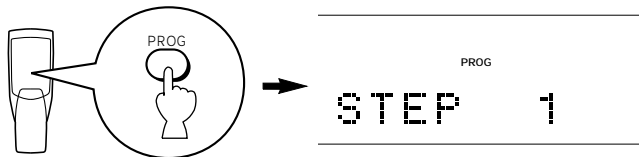

### 4 If necessary, select a desired disc.

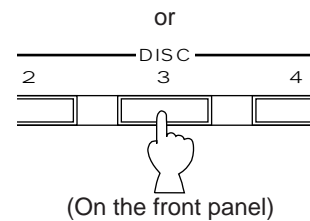
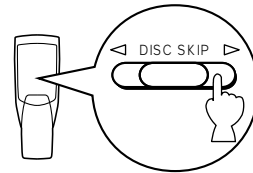

### 5 Program a desired track by pressing the corresponding numeric button.

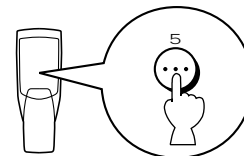

### 6 Repeat steps 4 – 5 to program more tracks. You can select the same track again.

### 7 When the programming is completed;

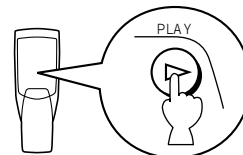

## Display information during programming

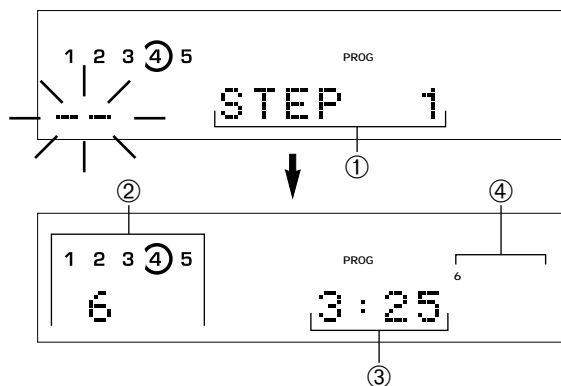

- ① Shows the program number for the track to be programmed next.
- ② Shows the selected disc and track number.
- ③ Shows the total time of the tracks currently programmed.
- ④ Shows only the numbers of programmed tracks on the selected disc.

\* If "STEP 1" does not appear on the display after the **PROG** button is pressed, press the **TEXT/TIME** display mode-select button.

\* If the total time exceeds 99 minutes and 59 seconds, the time will not be displayed.

### Notes

- You can program as many as 40 tracks at one time.
- You can program a whole disc by pressing "0", instead of one track. At that time, "ALL" lights up in the display.
- The total time of the programmed tracks will not be displayed, if a track number higher than 20 is programmed.
- If, during programming, the **TEXT/TIME** display mode-select button is pressed, the program number display can be changed to display the total time of the programmed tracks or no information. To return to the previous display, press the **TEXT/TIME** display mode-select button once again.
- The **SKIP** (◀◀ and ▶▶) button can be used during playing, but only within the range of the programmed tracks.
- Pressing a numeric button stops the current program and skips to the beginning of the track of the number pressed. Once that track has finished playing, the previously interrupted program resumes play.
- The **SEARCH** (◀◀ and ▶▶) button can be used during playing to search all tracks, including unprogrammed tracks.

## To stop program play

Press the **STOP** button. The first programmed track number will be displayed.

To resume play, press the **PLAY** button. Play will begin from the beginning of the program.

## To cancel a programmed sequence

There are several methods, as described below.

- Press the **STOP** button or the **CLEAR** button while the unit is stopped.
- Open the disc tray.
- Switch off the power.

## To check program data

1. During program play, press the **STOP** button.
2. Press the **PROG** button.
3. Each time the **SKIP** ▶▶ button is pressed, the track numbers and sequential order of the programmed tracks can be checked one after another. The display of the track number can be returned (sequentially in reverse order) by pressing the **SKIP** ◀◀ button.

## To correct program data

1. Follow the procedure described in "To check program data".
2. Display the track number to be corrected by pressing the **SKIP** button.
3. Press a numeric button to select a track to replace the one displayed. The previously programmed track will be cleared from the memory and the new one will be programmed.
4. After the correction has been completed, press the **PROG** button or **PLAY** button once again.

# REPEAT PLAY

You can play any desired track or disc (or a set of discs) repeatedly by pressing the **REPEAT** button. The repeat play mode will change whenever you press the **REPEAT** button.

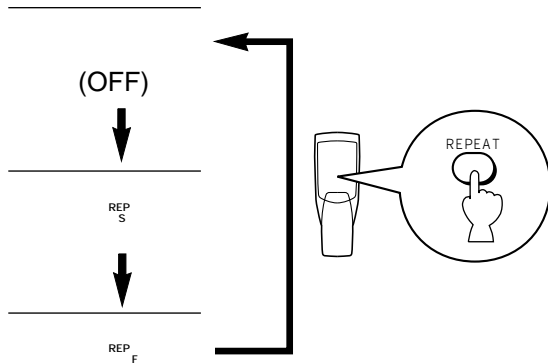

## SINGLE REPEAT (REP S)

A single track is repeatedly played.

\* This is also available in the program play mode and the random-sequence play mode. (If the repeat play mode is switched off, the program play mode or the random-sequence play mode will be resumed.)

## FULL REPEAT (REP F)

In the "1DISC" disc play mode: A designated disc is repeatedly played.

In the "5DISCS" disc play mode: All discs on the disc tray are repeatedly played.

\* In the program play mode, all programmed tracks are repeatedly played.

\* In the random-sequence play mode, all randomly sequenced tracks are repeatedly played in the same order.

# INDEX SEARCH

If the disc includes index numbers, play can be started from any desired index number.

**1** Select a track which has index numbers.

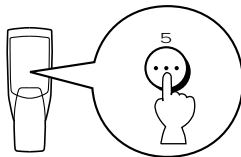

**2**

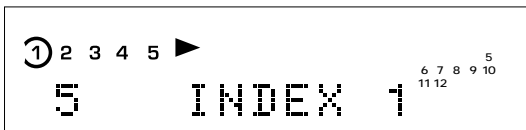
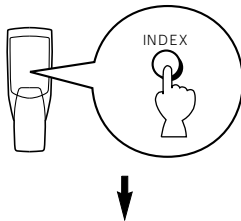

**3** Select the desired index number.

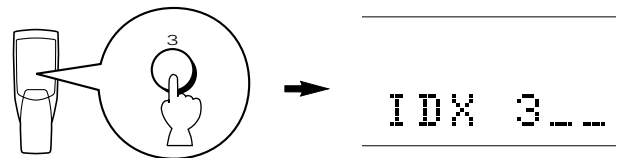

## To cancel the index search function

Press the **INDEX** button.

## Notes

- Not all discs have index numbers. The index system has a method for sub-dividing tracks into smaller divisions (for example, the movements within classical symphonies) for easier location of those parts. The liner notes with the disc usually tell if such index numbers are included.
- If an index number is selected that is higher than any index number on that disc, play will start from the last index number point on the disc.
- For some discs, play may begin slightly prior to the actual designated index point.
- If the disc has no encoded index points, play will begin from the start of the selected track.



# CD SYNCHRONIZED RECORDING

Using a compatible YAMAHA tape deck, you can synchronize the tape deck to start recording automatically when a CD starts playing. With this function, you can record a CD on tape more easily and precisely. (Refer to the tape deck's operation manual to know whether it is compatible or not.)

\* This unit and the tape deck must be placed close to each other so that both of them can receive the signals from this unit's remote control transmitter at the same time.

## CDC-675

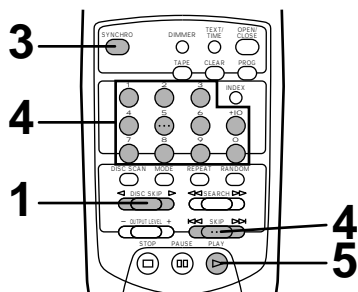

## CDC-575

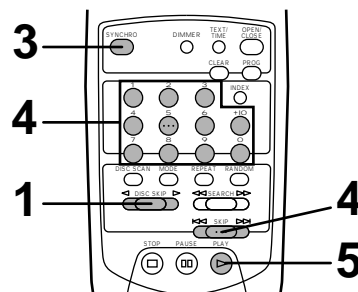

### 1 Select a disc.

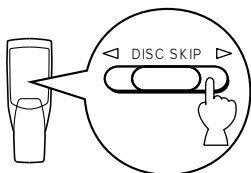

### 2 Load a tape on the tape deck.

#### \* CDC-675 only

The peak level searching function of this unit is useful for adjusting recording level on the tape deck. (Refer to page 21.)

### 3

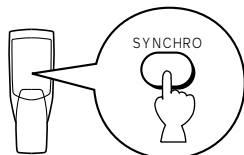

This unit enters into the pause mode, and the tape deck enters into the REC/PAUSE mode.

\* In this mode, the time display on this unit blinks.

### 4 If desired, select the track to be recorded first.

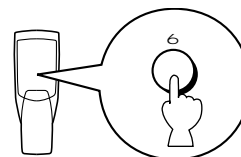

or

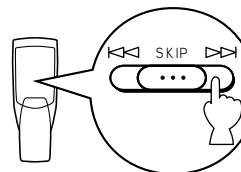

### 5

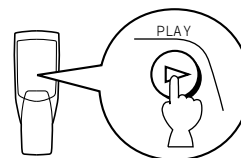

Both CD play and tape deck recording begin.

\* CD play begins a little later than recording.

### 6 If you want to stop recording temporarily and restart recording from a desired track, follow steps 3–5 again.

#### To cancel this function

Press the **STOP** button.

#### Notes

- To finish or stop recording, press the "STOP" button on the tape deck.
- Programmed sequence of tracks can also be recorded with this function, instead of recording an entire disc. (Refer to pages 14–15 for the programming procedure.)
- CDC-675 only**  
This function can also be used together with the automatic tape-programming function. (Refer to pages 18–20.)

# TRACK PROGRAMMING FOR RECORDING TO TAPE

## for CDC-675 only

This convenient feature can be used to program tracks for recording to tape. By only memorizing the tape's total possible recording time, the unit will automatically program tracks or help you to program tracks so they will fit onto the tape with the least amount of unrecorded space remaining at each end of the tape.

### Automatic tape programming

The unit will automatically program tracks on a disc with the original order of tracks unchanged.

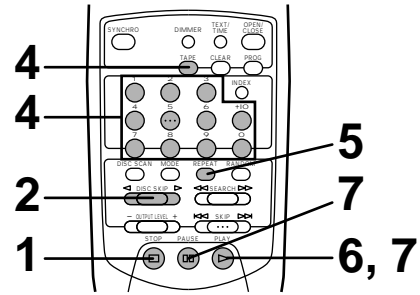

**1** Stop the unit.

**2** Select the disc.

**3** The peak level searching function of this unit is useful for adjusting recording level on the tape deck. (Refer to page 21.)

**4** Enter the tape's total possible recording time (tape length).

You can select any of four tape lengths by pressing the **TAPE** button.

You can also enter the tape's total possible recording time manually.

**Example:** For a C-64 tape (32 minutes on each side)

**5** Press the **REPEAT** button.

The unit automatically programs tracks for side A and side B separately considering the tape's total time.  
\* The programmed track numbers and the total number of tracks for side A and B are displayed for a short time.

**6** Begin recording on the tape deck and press the **PLAY** button on this unit's remote control transmitter at the same time.

**7** The unit will pause at the end of side A of the tape. Turn the tape over to side B. Resume recording and, at the same time, press the **PLAY** or **PAUSE** button on this unit's remote control transmitter.

- Notes**
- It is recommended that you use a tape that is slightly longer in length than the CD you are recording, because the programmed tracks on a CD may not fit properly into the time allowed on each half of the tape.
  - CD synchronized recording function can be used if your tape deck is compatible with it. In this case, in step 6 and 7, press the **SYNCHRO** button and then press the **PLAY** button on this unit's remote control transmitter. Recording automatically begins. (For details, refer to page 17.)

**Display information during programming**

① Shows the number of programmed tracks for each side in turn just after the automatic programming is finished, and then it is replaced by the number of the first programmed track for side A.

② Shows the total time of programmed tracks for each side.

③ Shows the programmed track numbers for each side.

## Manual tape programming

With this function, you can program tracks from one or more discs in any order to be recorded onto tape.

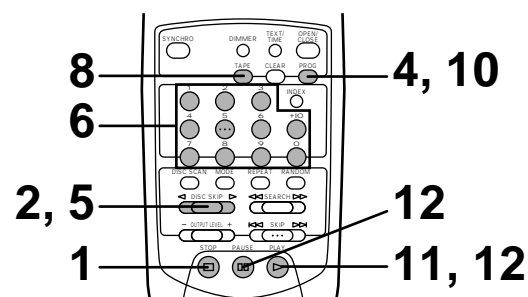

**1** Stop the unit.

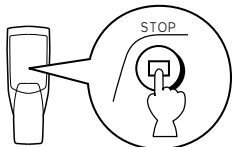

**2** If you will select tracks from a disc (or discs) other than the disc on the Disc 1 tray, make this unit display the total recorded time of each disc to be used by pressing the **DISC SKIP** button in turn.

\* This unit will read the contents of a disc by this operation. If there is a disc to which this operation is omitted, tracks on the disc cannot be programmed.

**3** Follow step 4 on page 18.

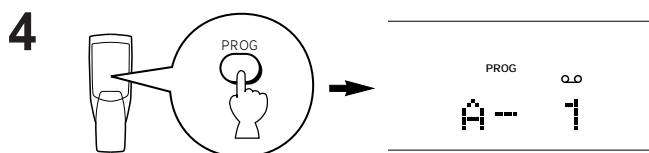

**5** If necessary, select a desired disc by pressing the **DISC SKIP** button.

**6** Select a desired track.

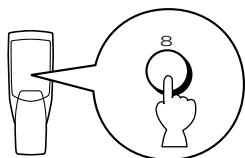

**7** Repeat steps 5 and 6 to program more tracks for side A of the tape. You can select the same track again.

\* If "ERROR" appears in the display, the track number just selected cannot be programmed because there is not enough time remaining on side A of the tape.

**8** When you finish the programming for side A, program the pause mode by pressing the **TAPE** button.

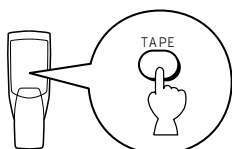

\* "PAUSE" lights up in the display, and after then you can begin programming for side B.

**9** Repeat steps 5 and 6 to program more tracks for side B of the tape.

You can select the same track again.

\* If "ERROR" appears in the display, the track number just selected cannot be programmed because there is not enough time remaining on side B of the tape.

**10** The peak level searching function of this unit is useful for adjusting recording level on the tape deck. For peak level searching, when the programming for side B is finished, press the **PROG** button and then press the **PEAK** button on the front panel. (Refer to page 21.)

**11** Start recording on the tape deck and press the **PLAY** button on this unit's remote control transmitter at the same time.

**12** The unit will pause at the end of side A of the tape. Turn the tape over to side B. Resume recording and, at the same time, press the **PLAY** or **PAUSE** button on this unit's remote control transmitter.

### Notes

- In steps 7 and 9, even if "ERROR" appears in the display, you can program another track of which time is shorter than the remaining time on the side of the tape. At this time, if any other track number lights up in the display, you can program it.
- CD synchronized recording function can be used if your tape deck is compatible with it. In this case, in steps 11 and 12, press the **SYNCHRO** button and then press the **PLAY** button on this unit's remote control transmitter. Recording automatically begins. (For details, refer to page 17.)

### Notes on tape programming

- To check, cancel or correct program data, refer to page 15.
- The maximum number of tracks that can be programmed is 40. If, however, the PAUSE mode is inserted, it is counted as one track.
- This function can be used to program up to track number 20. If the disc has more than 20 tracks, tracks with track number 21 and higher cannot be programmed.

## Display information during programming

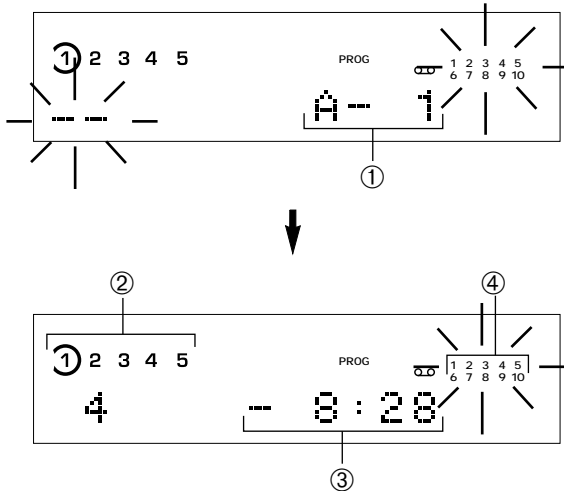

- ① Shows the side of the tape and the program number for the track to be programmed next.
- ② Shows the selected disc and track number.
- ③ Shows the total remaining time on the side of the tape.
- ④ Programmed track numbers light up and programmable track numbers among the unprogrammed ones blink.

\* If "A-1" does not appear in the display after the **PROG** button is pressed, press the **TEXT/TIME** display mode-select button.

\* If, during programming, the **TEXT/TIME** display mode-select button is pressed, the program number display can be changed to display the total remaining time on the side of the tape. To return to the previous display, press the **TEXT/TIME** display mode-select button once again.

## ■ Random sequential tape programming

The unit will automatically program tracks on a disc in random sequential order for recording to tape.

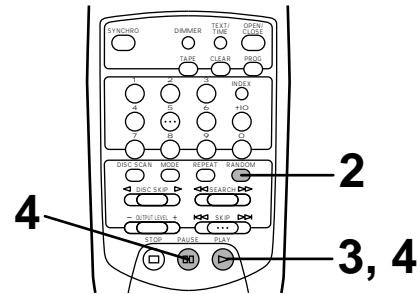

**1** Follow steps 1 – 4 on page 18.

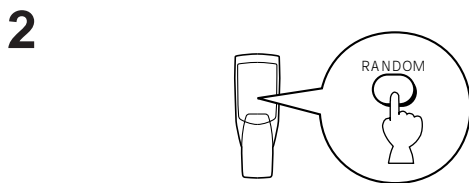

The unit will automatically program tracks for side A and side B separately considering the tape's total time.

\* The programmed track numbers and the total number of tracks for side A and B are displayed for a short time.

**3** Start recording on the tape deck and press the **PLAY** button on this unit's remote control transmitter at the same time.

**4** The unit will pause at the end of side A of the tape. Turn the tape over to side B. Resume recording and, at the same time, press the **PLAY** or **PAUSE** button on this unit's remote control transmitter.

### Notes

- Because the programmed data changes every time the **RANDOM** button is pressed, the amount of time remaining at the end of the tape also changes accordingly.
- It is recommended that you use a tape that is slightly longer in length than the CD you are recording, because the programmed tracks on a CD may not fit properly into the time allowed on each half of the tape.
- CD synchronized recording function can be used if your tape deck is compatible with it.

In this case, in steps 3 and 4, press the **SYNCHRO** button and then press the **PLAY** button on this unit's remote control transmitter. Recording automatically begins. (For details, refer to page 17.)

### Display information during programming

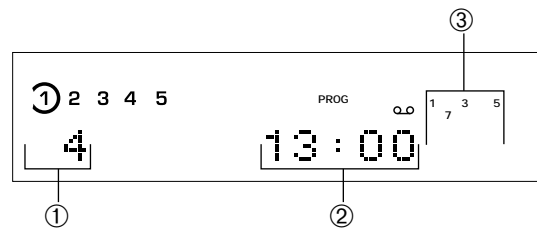

- ① Shows the number of programmed tracks for each side in turn just after the automatic programming is finished, and then it is replaced by the number of the first programmed track for side A.
- ② Shows the total time of programmed tracks for each side.
- ③ Shows the programmed track numbers for each side.

# AUTOMATIC SEARCHING FOR THE PEAK LEVEL ON A DISC

## for CDC-675 only

This convenient feature automatically searches a disc for a part where the source level peaks, and next plays the part repeatedly. For recording to tape, this feature is very helpful to adjust the recording level on the tape deck.

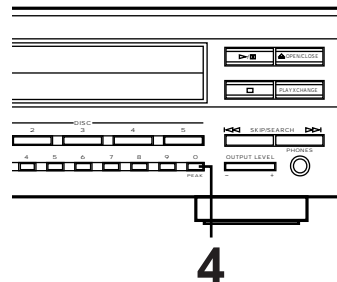
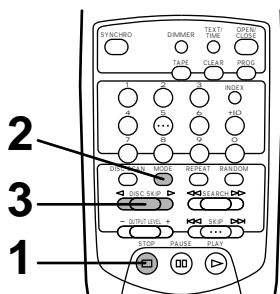

**1** Stop the unit.

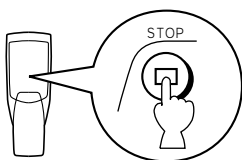

**2** Select the "1DISC" disc play mode.

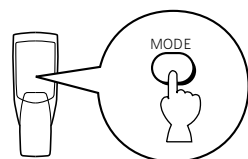

1DISC

**3** Select the disc.

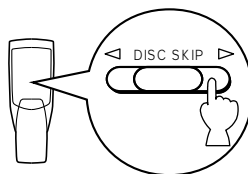

**4**

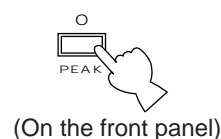

The peak level search is performed on the disc.

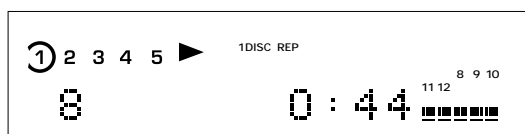

Next, the part where the source level peaks is repeatedly played. Adjust the recording level on the tape deck listening to this repeat play.

### To cancel this function

Press the **STOP** button.

### Notes

- Even if the peak level search is performed twice or more on the same disc, the same part will not be always selected, because this unit will search for the peak level among parts on the disc that are randomly selected by the internal microcomputer.
- In the program play mode, this feature will function among the programmed tracks only. If program play is being performed, first press the **STOP** button, and then press the **PEAK** button. If program play is not being performed, only press the **PEAK** button.
- To search for the peak level through all discs on the disc tray, in step 2, select the "5DISCS" disc play mode.

# NOTES ABOUT THE REMOTE CONTROL TRANSMITTER

## Battery installation

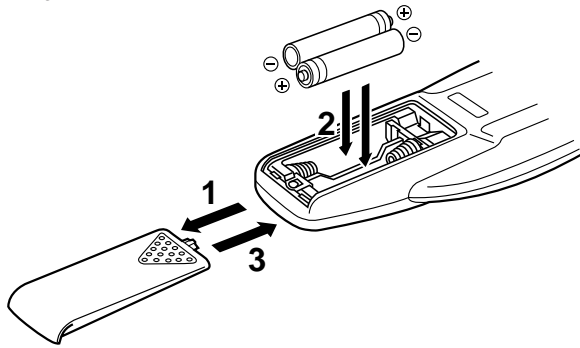

## Battery replacement

If you find that the remote control transmitter must be used closer to the main unit, the batteries are weak. Replace both batteries with new ones.

### Notes

- Use only AA, R6, UM-3 batteries for replacement.
- Be sure the polarities are correct. (See the illustration inside the battery compartment.)
- Remove the batteries if the remote control transmitter will not be used for an extended period of time.
- If batteries leak, dispose of them immediately. Avoid touching the leaked material or letting it come in contact with clothing, etc. Clean the battery compartment thoroughly before installing new batteries.

## Remote control transmitter operation range

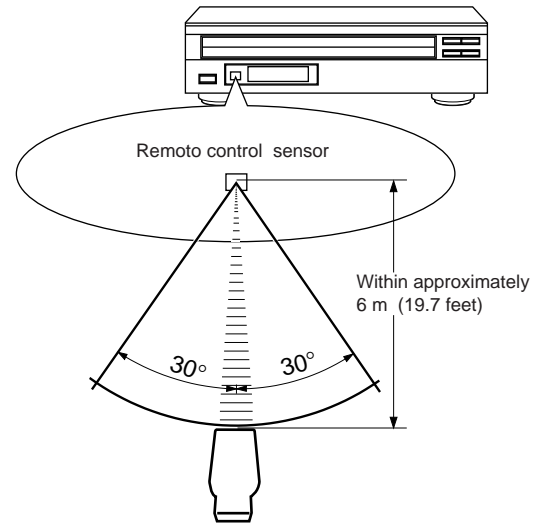

### Notes

- There should be no large obstacles between the remote control transmitter and the main unit.
- If the remote control sensor is directly illuminated by strong lighting (especially an inverter type of fluorescent lamp, etc.), it might cause the remote control transmitter not to work correctly. In this case, reposition the main unit to avoid direct lighting.

## TIMER PLAY **for CDC-675 only**

You can start play at any specified time by connecting a timer (sold separately). Refer also to the instructions for the timer.

1. Select the desired play mode (1DISC or 5DISCS).
2. Press the **POWER** switch to turn the unit off.
3. Press the **POWER** switch while pressing the **PLAY/PAUSE** (▶/⏸) button on the front panel.  
Shortly thereafter, "TIMER P. ON" appears in the display and the timer play function is on.  
(When the timer play function is already on, in which case, "TIMER P. OFF" appears in the display and timer play function is off.  
In this case, repeat the procedure in steps 2 and 3 to set the timer play function to on.)
4. Set the timer to the desired time.  
When the set time comes, the unit turns on and starts play.

## NOTES ABOUT HANDLING COMPACT DISCS

- This compact disc player is designed for playing compact discs bearing the  mark only. Never attempt to load any other type of disc into the unit. The unit will also play 8-cm (3-inch) compact discs.

- Compact discs are not subjected to wear during play, but damage to the disc surface when the disc is being handled can adversely affect the disc's play.

- Do not use cleaning discs or warped discs. All of these could damage the unit.

### To prevent a malfunction of this unit

- Do not use any non standard shaped CD (heart, etc.) available on the market, because it may damage the unit.

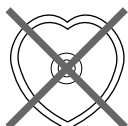

- Do not use a CD with tape, seals, or paste on it, because damage to the unit may result.

- Compact discs are not affected by small particles of dust or fingerprints on their playing surface, but even so they should be kept clean. Wipe by using a clean, dry cloth. Do not wipe with a circular motion; wipe straight outward from the center.

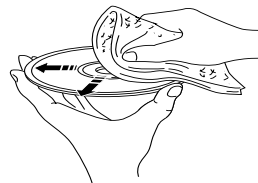

- Do not try to clean the disc's surface by using any type of disc cleaner, record spray, anti-static spray or liquid, or any other chemical-based liquid, because such substances might irreparably damage the disc's surface.
- Do not expose discs to direct sunlight, high temperature or high humidity for a long period of time, because these might warp or otherwise damage the disc.



# TROUBLESHOOTING

If the unit fails to operate normally, check the following points to determine whether the problem can be corrected by the simple measures suggested. If it cannot, or if the problem is not listed in the SYMPTOM column, disconnect the unit's power cord and contact your authorized YAMAHA dealer or service center for help.

SYMPTOM	PROBABLE CAUSE	REMEDY
<b>This unit does not switch ON when the POWER switch is pressed.</b>	The power cord is not connected or not completely connected.	Securely connect the power cord.
<b>This unit does not work normally.</b>	There is an influence of strong external noise (lightning, excessive static electricity, etc.) or a misoperation was performed while using this unit.	Turn off and disconnect the AC power from the AC outlet. After about 30 seconds, connect the power and try again.
<b>The disc tray does not close completely.</b>	A foreign object is obstructing the tray.	Carefully check the disc tray and remove the foreign object.
<b>A disc number does not light up on the display.</b>	The disc has been loaded upside down.	Reload the disc with the label side up.
	The disc is damaged.	Check the disc carefully; replace it if necessary.
	There is moisture on the laser pickup.	Wait 20 to 30 minutes after switching the unit ON before trying to play a disc.
<b>Play does not begin.</b>	The disc is damaged.	Check the disc carefully; replace it if necessary.
	The disc has been loaded upside down.	Reload the disc with the label side up.
	The disc is dirty.	Clean the disc.
<b>Play is delayed, or begins at the wrong place.</b>	The disc may be scratched or damaged.	Check the disc carefully; replace it if necessary.
<b>No sound.</b>	Improper output cable connections.	Connect the cables properly. If the problem persists, the cables may be defective.
	Improper amplifier operation.	Set the amplifier controls to the correct input selection.
<b>Sound "skips".</b>	This unit is being subjected to vibrations or impacts.	Relocate this unit.
	The disc is dirty.	Clean the disc.
<b>Sound "hums".</b>	Improper cable connections.	Securely connect the audio cables. If the problem persists, the cables may be defective.
<b>Noise from a nearby tuner.</b>	The tuner is too close to this unit.	Move the tuner and this unit farther apart.
<b>Noise from inside of the disc tray.</b>	The disc may be warped.	Replace the disc.
<b>The remote control transmitter does not work.</b>	The batteries of this remote control transmitter are too weak.	Replace the batteries with new ones.
	Direct sunlight or lighting (of an inverter type of fluorescent lamp, etc.) is striking the remote control sensor of the main unit.	Change position of the main unit.

# SPECIFICATIONS

## AUDIO SECTION

Frequency response .....	2 Hz – 20 kHz, ±0.5 dB
Harmonic distortion+noise (1 kHz)	
<CDC-675> .....	0.003% or less
<CDC-575> .....	0.004% or less
S/N ratio	
<CDC-675> .....	106 dB or more
<CDC-575> .....	102 dB or more
Dynamic range	
<CDC-675> .....	96 dB or more
<CDC-575> .....	95 dB or more
Output level (1 kHz, 0 dB) .....	2.0±0.5V
Headphones output (–20 dB) .....	200±40 mV/150 ohms (CDC-675 only)

## GENERAL

<b>Power requirements</b>	
U.S.A. and Canada models .....	120V, 60 Hz
Australia model .....	240V, 50 Hz
Europe and U.K. models .....	230V, 50 Hz
General model .....	110/120/220/240V, 50/60 Hz
<b>Power consumption</b> .....	20W
<b>Dimensions (W x H x D)</b> .....	435 x 116 x 404 mm (17-1/8" x 4-9/16" x 15-7/8")
<b>Weight</b> .....	5.8 kg (12 lbs. 12 oz.)
<b>Accessories</b> .....	Connection cord Remote control transmitter Batteries (size AA, R6,UM-3)

Please note that all specifications are subject to change without notice.





---

YAMAHA ELECTRONICS CORPORATION, USA 6660 ORANGETHORPE AVE., BUENA PARK, CALIF. 90620, U.S.A.  
YAMAHA CANADA MUSIC LTD. 135 MILNER AVE., SCARBOROUGH, ONTARIO M1S 3R1, CANADA  
YAMAHA ELECTRONIK EUROPA G.m.b.H. SIEMENSSTR. 22-34, 25462 RELINGEN BEI HAMBURG, F.R. OF GERMANY  
YAMAHA ELECTRONIQUE FRANCE S.A. RUE AMBROISE CROIZAT BP70 CROISSY-BEAUBOURG 77312 MARNE-LA-VALLEE CEDEX02, FRANCE  
YAMAHA ELECTRONICS (UK) LTD. YAMAHA HOUSE, 200 RICKMANSWORTH ROAD WATFORD, HERTS WD1 7JS, ENGLAND  
YAMAHA SCANDINAVIA A.B. J A WETTERGRENS GATA 1, BOX 30053, 400 43 VÄSTRA FRÖLUNDA, SWEDEN  
YAMAHA MUSIC AUSTRALIA PTY, LTD. 17-33 MARKET ST., SOUTH MELBOURNE, 3205 VIC., AUSTRALIA

YAMAHA CORPORATION

Printed in Malaysia © V317310